

# EVO Max 4N

Maintenance Manual

May 2023

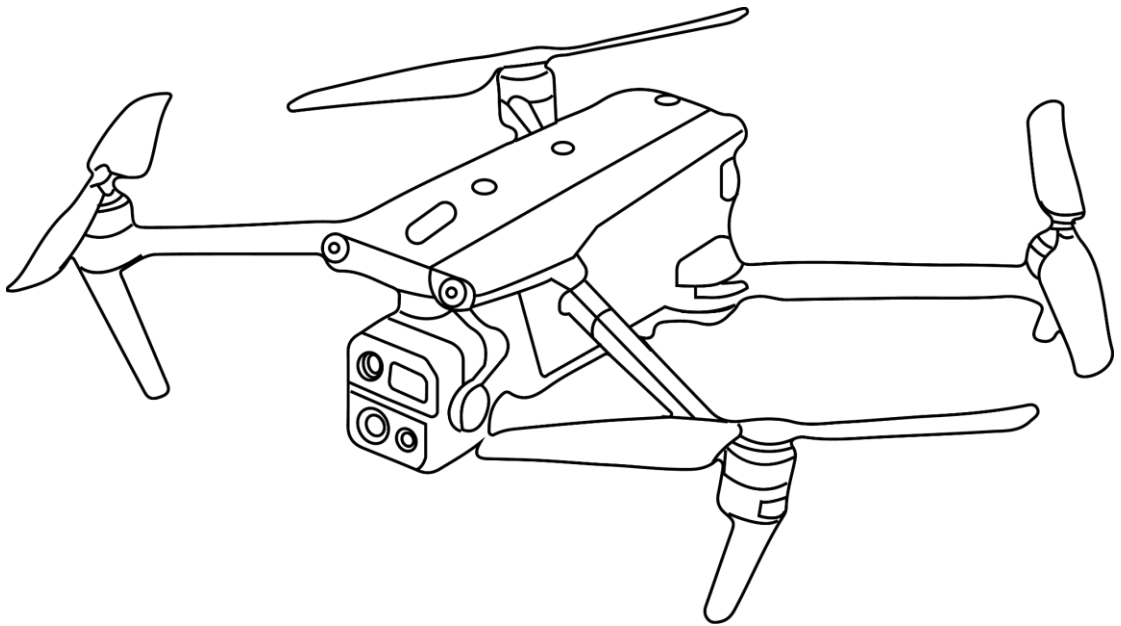

# Contents

<b>Introduction And Overview</b>	2
<b>Usage Agreement</b>	2
<b>Safe Flight Guidelines</b>	2
Flight Condition Requirements	2
Operational Requirements	2
Flight Restrictions	2
Transportation Guidelines	3
Firmware Upgrade	3
<b>Maintenance And Checks</b>	3
Pre-flight Checks	3
Maintenance And Checks	4
Component Inspection	4
Power system	4
Flight Control System	6
Fuselage	6
Battery	9
Upgrades And Calibration	11
Consumable Parts List	11
<b>After-Sales Service</b>	12
Warranty Policy	12
Warranty Period For Main Components (12-month guarantee on whole product)	12
Other Parts	12
Flight Accident Handling	12
Lost in Flight Incidents	12
Collision Or Crash	13
Shipping Channels	13

## **Introduction And Overview**

This document is designed to provide certified advice and precautions in inspection, maintenance and usage of the EVO Max 4T. This includes assisting users in daily maintenance and ongoing maintenance of the unit. Please read both the “User Manual” and “Maintenance Manual” carefully for the best possible product experience.

If you have any questions about maintenance, usage, or the EVO Max 4T generally, please contact the official technical support team of Autel Robotics.

## **Disclaimer**

The different operations outlined in this document must be carried out in conditions that satisfy the requirements, and it is forbidden to complete related operations in an illegal and unsafe way.

Upon using this product, you are deemed to have read this document carefully, understood and accepted all the terms and contents of this document and all related documents of this product. Autel Robotics are not responsible for any damage and any legal responsibility caused by the direct or indirect use of this product.

This product manual is copyrighted by Autel Robotics Co., Ltd. All copyrights, trademark rights, patent rights, trade secrets and other intellectual property rights of this product manual, as well as all information related to this product manual (including but not limited to text, pictures, audio, video, graphics, interface design, layout framework, relevant data or electronic documents, etc.) are protected by all relevant laws and regulations, with Autel Robotics enjoying the above-mentioned intellectual property rights. It may not be reproduced in any form without permission. The final interpretation right of this document and all related documents of this product belongs to Autel Robotics Co., Ltd. Subject to update without notice. Please visit <https://www.autelrobotics.com/>, the official website, for the latest product information.

## **Safe Flight Guidelines**

### **Flight Condition Requirements**

#### **Operational Requirements**

Before using the product, please read the Disclaimer, “User Manual” and “Maintenance Manual” carefully.

#### **Flight Restrictions**

Please regularly update the flight restriction database online, and consult relevant local authorities before flying to ensure compliance with local laws and regulations.

Before flying in a restricted flight zone, please apply for a waiver in advance.

## **Transportation Guidelines**

The storage and transportation of smart batteries have certain safety requirements. Please strictly follow the contents of the "Battery Safe Operation Guidelines" for the best practices.

### **Firmware Upgrade**

Before each use, it is recommended to update the firmware of the aircraft, intelligent flight battery and remote controller to the latest for a better experience. Please refer to the User Manual for firmware upgrade methods and precautions.

If the upgrade fails, please restart the device and try again. If you still can't solve the problem, please contact the official after-sales service of Autel Robotics.

## **Maintenance And Checks**

It's important to regularly carry out inspections and regular maintenance before operating the drone, as this can greatly improve product reliability, reduce potential safety hazards, and prolong drone service life.

### **Pre-flight Checks**

Before each flight, the following items must be checked:

1. The batteries of the remote controller and the aircraft are fully charged, and the batteries must be installed in place without detaching;
2. Make sure that the propeller is an authentic Autel Robotics supplied propeller, the appearance is intact, it is installed firmly, the front and back propellers are both installed correctly, there is no foreign matter or debris in the motor and propeller, and there is no blockage in the manual rotation of the motor;
3. Make sure that the arms are fully unfolded, and ensure that the arms do not rebound and have a strong pre-tightening force;
4. Make sure that drone camera normal, and the lens is free of oil, occlusion, and fingerprints;
5. Make sure that the gimbal motor has been stabilized and the camera is facing the normal direction;
6. Make sure that the protective cover of the card slot and interface is securely closed, otherwise water may enter and affect the flight;
7. Make sure the antennas of the remote controller are unfolded and adjusted to an optimal angle;
8. Turn on the remote controller and the aircraft, check whether the indicator lights of the remote controller and the aircraft are normal, ensure that the remote controller is connected to the aircraft normally, and can correctly control both flight and gimbal;
9. Enter the flight interface of Autel Enterprise, check whether the flight status is "Safe to fly", whether the obstacle avoidance function is turned on normally, and check whether any other parameters you may require are met in the settings to ensure flight safety;
10. If multiple aircrafts are operating at the same time, please pay attention to your flight area to avoid collisions and accidents.

## Maintenance And Checks

It is recommended that users refer to the following standards to carry out regular inspections and maintenance to maintain the best condition of the aircraft and reduce potential safety hazards.

Type	Maintenance Item	Advice	Cycle
Basic	Deep cleaning, component inspection, calibration	Recommended to return to factory or contact Autel Robotics authorized dealer	Frequency decided by user based on usage
Standard	Deep cleaning, component inspection, calibration, replacement of wearing parts	Return to factory	Every 300 flight hours or every year
Premium	Deep cleaning, component testing, calibration, replacement of wearing parts, power system replacement	Return to factory	Every 900 flight hours or every 3 years

\*Maintenance Cycle or flight time is whichever comes first.

\*Time stated (every year or every 3 years) is noted as the time since activation.

For different regions, Autel Robotics may adjust the maintenance type and cycle. For the latest service details, please consult your local dealer or Autel Robotics After-Sales team

## Component Inspection

### Power System

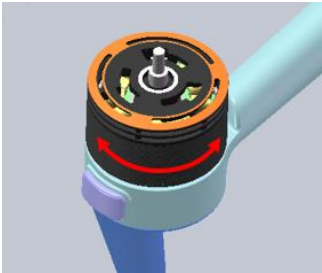
Type	Inspection Process	Guide
Motor Rotation	<ol style="list-style-type: none"> <li>1. Unfold the arm;</li> <li>2. Remove the propeller and visually check for foreign objects in the inner chamber of the rotor, clean carefully as to not scratch the coils.</li> <li>3. Rotate the motor to check whether there is any jamming, scratching or odd sounds. Visually inspect the motor and base to check for foreign objects;</li> </ol>	

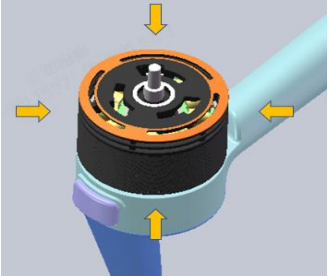
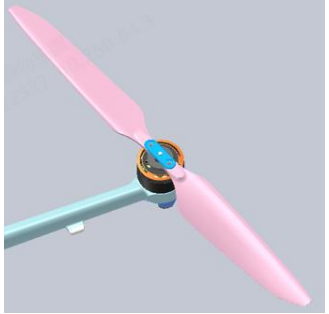
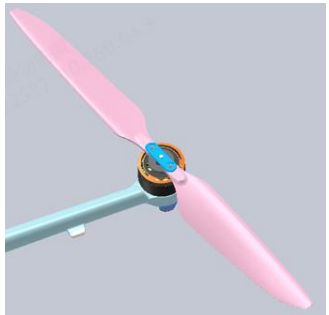
	<ol style="list-style-type: none"> <li>When checking the rotation of the motor, if there is freezing, scratching, etc., do not fly. It needs to be repaired.</li> </ol>	
Motor Tightness	<ol style="list-style-type: none"> <li>Shake the motor vertically to check whether the motor screws are loose or the arm is aging;</li> <li>If screws are loose, it needs to be repaired or proceed maintenance.</li> </ol>	
Blades	<ol style="list-style-type: none"> <li>Visually inspect the blades for any deformation, severe wear, damage or cracks, or if anything is attached to the surface;</li> <li>Use a dry soft cloth to clean blades until free of any dirt;</li> <li>If the blades are obviously deformed, severely worn, notched, or cracked, do not fly and replace the blades promptly.</li> </ol>	
Blade Clamps	<ol style="list-style-type: none"> <li>Check whether the clamp rivets are secure and well fastened;</li> <li>Check for any deformations or breaks;</li> <li>If you find any deformation, please replace the clamps promptly.</li> </ol>	

\*It is recommended to replace the propeller blades only in emergency situations in field operations; after any emergency flight, please contact the official technical support or authorized agent of Autel Robotics for maintenance guides promptly.

## Flight Control System

1. The "Visual Positioning Mode" will appear after turning on the aircraft. Please observe the surrounding environment and place the aircraft in an open and unobstructed environment to search for satellites. If the number of searched satellites is more than 28, this is good and within the recommended range.





2. If the app prompts "Compass abnormal", please stay away from interference areas and recalibrate.



3. If the app prompts "IMU is abnormal", please perform an IMU calibration. If the problem cannot be solved, please contact Autel After-Sales service.
4. If the app prompts "Barometer abnormal", please restart the aircraft and try again. If the abnormality continues, please contact Autel After-Sales service.

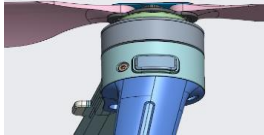

## Fuselage

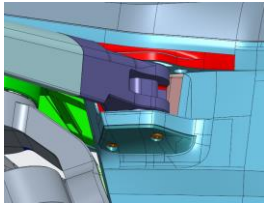
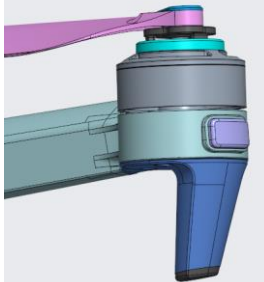
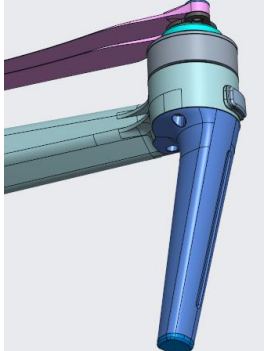
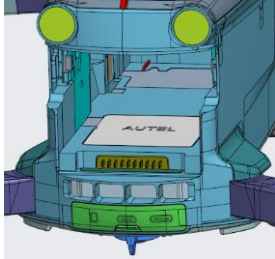
Type	Inspection Process	Guide
Appearance	<ol style="list-style-type: none"> <li>1. The appearance of the fuselage should be clean, without signs of damage or deformation;</li> <li>2. Wipe the fuselage with a clean soft cloth, paying special attention to the cleaning of the perception sensing system, lenses and heat dissipation vents.</li> </ol>	

Screws	<ol style="list-style-type: none"> <li>1. Check all screws of the fuselage and make sure there are no loose screws or any missing screws.</li> </ol>	 
Folding Arms	<ol style="list-style-type: none"> <li>1. Check all for any loosening screws;</li> <li>2. Check for any damage or cracks on the conjunction between the arm and fuselage;</li> <li>3. When the arm is unfolded, check to see if there is any obvious gap between the arm and fuselage;</li> <li>4. Ensure when folding the arms inwards or outwards that there is no jamming or abnormal noise- it should be smooth.</li> </ol>	
Arm Indicator	<ol style="list-style-type: none"> <li>1. Check whether the surface is dirty or damaged.</li> </ol>	
Landing gear	<ol style="list-style-type: none"> <li>1. Check whether the landing gear and the arm are firmly fixed together, and whether any screws are loosening or any missing screws.</li> </ol>	
Battery Compartment	<ol style="list-style-type: none"> <li>1. Check whether there is dirt, water stains or corrosion marks in the battery interface. If any, please wipe it clean;</li> <li>2. Ensure the buckles at two sides of battery rebounds strongly when pushed;</li> <li>3. After the battery is installed, the battery buckles should push back normally without obvious shaking.</li> </ol>	

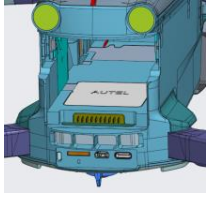
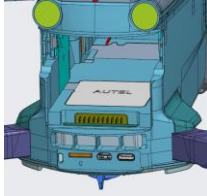
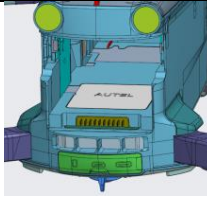
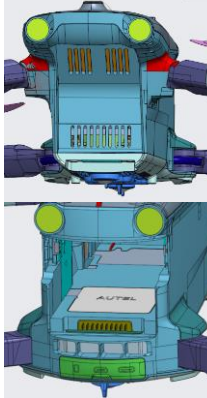
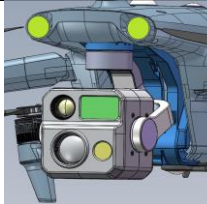

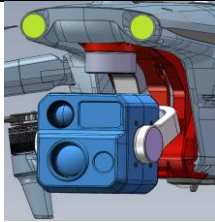
Data Interface	<ol style="list-style-type: none"> <li>1. Wipe off any foreign debris near the interface;</li> <li>2. Check the interface to see whether there is any foreign matters;</li> <li>3. Use tweezers to remove any debris in the interface, such as small stones and small pieces of paper;</li> <li>4. Use gauze to wipe off any glue-like matter at the interface;</li> <li>5. Tilt the aircraft, with the interface facing downwards, and use gauze, a small brush or other tools to remove any other powdery foreign matter in the interface. Note that the cleaning method needs to be from the inside to the outside.</li> </ol>	
Micro SD Card Interface	<ol style="list-style-type: none"> <li>1. Check whether there are foreign objects in the Micro SD card slot, and whether the microSD card is removed and installed normally;</li> <li>2. Check whether the reading and writing of the Micro SD card is normal.</li> </ol>	
Protective Cover	<ol style="list-style-type: none"> <li>1. The plug should not be loose or damaged.</li> </ol>	
Vents	<ol style="list-style-type: none"> <li>1. Check whether the cooling vents are unobstructed, and whether the cooling fan is stuck or making abnormal noises.</li> </ol>	
Dampeners	<ol style="list-style-type: none"> <li>1. Double check if the dampeners are damaged, loose, aged, softened or stretched;</li> <li>2. Check whether the screws on the connecting plate are loose.</li> </ol>	
	<ol style="list-style-type: none"> <li>1. Before powering on the aircraft, check whether the lenses are damaged or cracked, and make sure the gimbal</li> </ol>	

<p>Gimbal Camera</p>	<p>camera is in good condition.</p> <ol style="list-style-type: none"> <li>Power on the aircraft. The gimbal's self-calibration is complete after 5s, at which point the camera is pointed directly forward. Check the gimbal's stability by shaking the airframe.</li> <li>Turn the gimbal's pitch upwards and downwards gently to check whether the gimbal's motor can rotate smoothly without vibration.</li> <li>Connect the aircraft to a remote controller, and check whether the images from the three cameras are displayed properly on the remote controller.</li> </ol> <p>If no abnormality is found in the preceding steps, the gimbal camera works properly.</p>	
<p>Perception System, Lenses, Spotlight, Strobe</p>	<ol style="list-style-type: none"> <li>Wipe the lenses with a soft cloth;</li> <li>Check whether any lenses have fallen off or cracked;</li> <li>Whether the lens of spotlight or strobe are missing, loosened or cracked.</li> </ol>	

## Battery Life

To prolong battery life, please avoid the following situations:

- Avoid placing the battery in an environment with a temperature above 28°C for a long time. The ideal storage temperature is 22-28°C.
- Avoid storing fully-charged batteries for a long time. In order to protect the battery, BMS has a self-discharge function, lasting for 2-3 days. It is recommended to charge the battery to 60~75% before storage instead of activating the self-discharge function.
- Avoid low battery storage. If the power is too low, BMS will enter ultra-low power protection. The battery itself has self-discharge, and if the battery is too low, it will damage the battery.
- Avoid placing the battery in a high-humidity and high-salt environment for a long time, which may damage the interface and shell.
- Do not use unauthorized chargers. The voltage and current output by unauthorized chargers cannot fully match the battery cells, which may cause damage to the batteries.
- Avoid leaving the charger plugged in for a long time as this may damage the charger.

## **Battery Maintenance Conditions**

In order to keep the aircraft battery healthy, maintenance is recommended if any of the following conditions are met:

1. The battery has been cycled 50 times.
2. The battery has been inactive for 3 months.
3. The App prompts users that the battery needs maintenance.

## **Battery Inspection Process**

1. The battery performs a standard charge and discharge operation.
2. Insert the battery into the aircraft and power on, check the battery information through the app, check whether the voltage difference between the battery cells is less than 0.1V, and whether the battery firmware is up to date.
3. Check whether the battery is bulged, leaked, or damaged.
4. Check the battery connector for dirt, damage or rust.

## **Charging And Discharging a Battery**

Use the original charger, or the maintenance charging mode of the charging box, charge to 100% and let it stand for 24 hours. Then discharge to below 20% and let it stand for 1 hour.

1. Charge the battery to 100% and let it sit for 24 hours.
2. Insert the battery into the aircraft to fly, when the battery is less than 20%, land the aircraft. After landing, remove the battery.
3. Let the battery stand for 1 hour.
4. After completing the battery maintenance process, it can be charged and stored.

## **Battery Replacement Standards**

1. There are obvious bulges, leakage, and damage on the battery surface.
2. Replacement is recommended after 300 cycles.
3. After 2 consecutive standard charging and discharging operations, if the abnormality of the battery still cannot be recovered, it is recommended to replace it.

## **Battery Disposal**

1. Use an insulated bucket filled with 5% salt water and fully submerge in it for more than 48 hours until fully discharged.
2. After step 1, refer to the "Battery Safe Operation Guidelines" for correct recycling procedures to avoid any environmental pollution.

## **Precautions**

1. Keep away from flammable and explosive items during charging.
2. Avoid using the battery in a humid environment to prevent the battery from short-circuiting.
3. Do not disassemble or puncture the battery.
4. Store the battery in a cool and dry place.

5. If the app prompts that the battery temperature is too high during flight, please return to home as soon as possible.

## Upgrades And Calibration

Please update the firmware of the aircraft and remote controller regularly, and perform regular calibrations.

No.	Classification
1	Aircraft Firmware Upgrade
2	Remote Controller Firmware Upgrade
3	IMU Calibration
4	Compass Calibration
5	Vision System Calibration
6	Gimbal Calibration

## Consumable Parts List

Replace damaged and consumed parts promptly to keep the aircraft in the best possible condition and reduce any potential safety hazards.

No.	Classification	Quantity
1	Blade CW*	4
2	Blade CCW*	4
3	Motor**	4
4	Rear landing gear	2
5	Front landing gear	2
6	Conjunction cover	4
7	Battery Removal Button	2
8	Air Inlet Dust Filter	1
9	Air Outlet Dust Filter	1
10	Remote Controller Stick	2

\*Each power motor uses 2 blades CW or CCW.

\*\*Replacement only required for deep maintenance.

## After-sales service

### Warranty Policy

Note that the warranty period may vary according to local laws and regulations.

Warranty period for main components (12 months for the whole machine):

Aircraft Parts	Warranty Period
Flight Control System	12 months
Fuselage	12 months
Motor	12 months
ESC	12 months
Antenna	12 months
Gimbal Camera	12 months

Warranty period for other parts (optional accessories):

Other Parts	Warranty Period
Battery	12 months and the number of cycles is less than 200
Smart Remote Controller	12 months
Rugged Case	3 months

### Flight Accident Handling

When your aircraft encounters a flight accident, please follow the steps below to deal with it.

#### Lost in Flight

1. Please contact Autel Robotics Technical Support as soon as possible to describe the situation in detail;
2. Please check the flight records through Autel Enterprise, and look for the aircraft at the location where the data was interrupted according to the actual terrain;
3. Connect the remote controller to the computer, export flight control data and flight records, and contact Autel Robotics Technical Support or your local agent for data analysis;
4. Autel Robotics will give a solution based on the analysis results.

#### Collision, Crash

1. Please take pictures of the aircraft and surrounding environment promptly after the accident, and record the status of the aircraft leading up to the accident;

2. Please confirm that the aircraft is powered off, remove the battery from the aircraft, and use an isolation box to store the battery. Please note: Do not turn on the aircraft again! If the accident is serious, further damage could occur to internal components;
3. Connect the remote controller to the computer, export flight control data and flight records, and contact Autel Robotics Technical Support or your local agent for data analysis;
4. Please send the device back for repair.

## **Shipping Channels**

Autel Robotics provides the following repair channels, with any of the following methods being suitable:

### **1. Contact an agent for assistance.**

Please contact your local agent, describing the type of service required, and the agent will assist you in completing the repair of the product where possible.

### **2. Autel Robotics Technical Support.**

Please call the official technical support hotline at (844) MY AUTEL or (844) 692-88 35, or email to [support@autelrobotics.com](mailto:support@autelrobotics.com). Please describe the type of service required to the service specialist, such as maintenance, return, etc., then send the product back according to the guidelines.