

David White[®]

OPERATING MANUAL



models
DT8-05P, DT8-05LP, DT05LS

DIGITAL THEODOLITE



IMPORTANT:
Read Before Using

IMPORTANT:
Lire avant usage

IMPORTANTE:
Leer antes de usar

Set Your Sights On Precision and Accuracy with David White®

Thank you for your purchase of this David White laser instrument. The purpose of this user's guide is to acquaint you with your instrument, its components, safety, proper care, and handling.

Our instruments are constructed to withstand rugged field use. Like all precision instruments, however, they should be treated with reasonable care to prolong life and accuracy.

IMPORTANT! All instruments are adjusted when they are shipped from the factory. It is the customer's responsibility to check and to ensure instruments are adjusted prior to using.

A accuracy check is recommended before the initial use of your instrument, and then periodically from that point forward (**see Accuracy Check**). If your instrument is dropped or you have uncertainty, then return it to your reseller for a calibration check and adjustment if needed.

David White® Brand is exclusive of Dave White's SitePro LLC. SitePro is not responsible for errors caused by instruments that are out of adjustment. It is important that you read the entire instruction manual before use of this instrument for care and maintenance.

We would appreciate your feedback on this product or any other product comments or suggestions. Please send to **info@sitepro.us.com**



DT8-05 Digital Theodolite

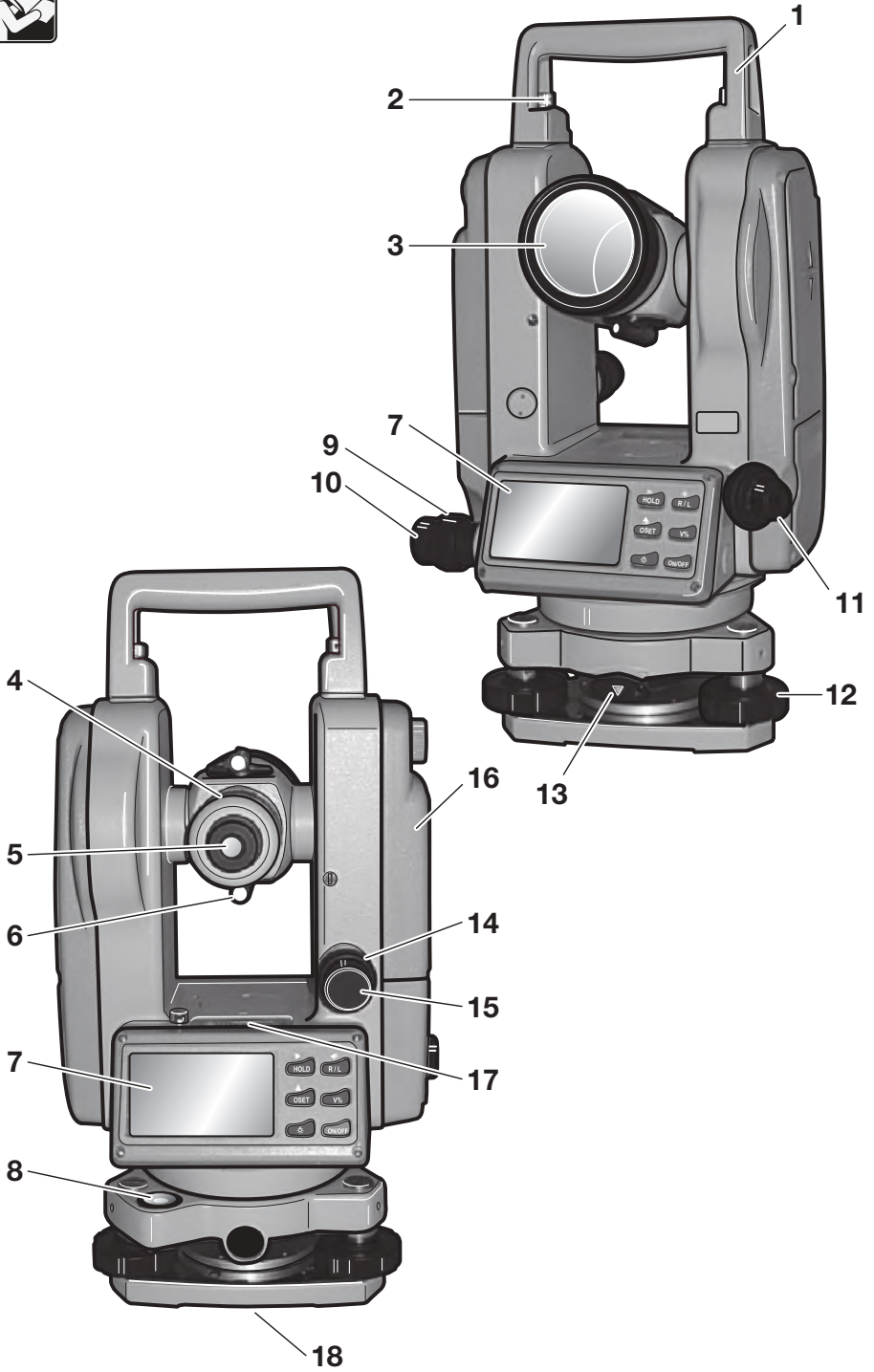

GENERAL SAFETY RULES

⚠ WARNING Read all instructions. Failure to follow all instructions listed below may result in serious injury.

⚠ WARNING When moving a tripod-mounted instrument, handle with care. Carry only in an upright position. Do not carry over your shoulder or in a horizontal position. Improper handling may result in instrument damage

Handle the instrument by its base when removing from the case or attaching to a tripod. Never use force on any parts of the instrument. All moving parts will turn freely and easily by hand.

DO NOT directly aim the telescope to the Sun to avoid injury to your eyes

Check the leveling and indication accuracy of the instrument each time before using and after longer transport of the instrument.

Protect the instrument against moisture and direct sun light.

DO NOT subject the instrument to extreme temperatures or variations in temperature.

As an example, do not leave it in vehicles for long time. In case of large variations in temperature, allow the instrument to adjust to the ambient temperature before putting it into operation. In case of extreme temperatures or variations in temperature, the accuracy of the instrument can be impaired.

This instrument contains many sensitive electronic components and is provided with protection against dust and moisture. Once dust or moisture enters into the instrument they will cause damage to the instrument. Therefore, after using in a humid environment, the instrument must be dried immediately and stored in the instrument case.

Avoid any impact to or dropping of the instrument. After severe exterior effects to the instrument, it is recommended to carry out an accuracy check (see “Checks and Adjustments”, page 15) each time before continuing to work.

Place the instrument in the provided case when transporting it over larger distances (e.g. in the car). Ensure that the instrument is correctly placed in the transport case. When placing the instrument in the case.

When carrying instrument, always remove the instrument from the tripod when transporting or carrying it at the jobsite. If the instrument must be carried on the tripod, hold the instrument as vertically as possible and keep it in front of you. Never carry the instrument horizontally over your shoulder.

When transporting instrument long distances, always place in the carrying case.

SAVE THESE INSTRUCTIONS

INTENDED USE

The instrument is intended for determining and checking precise measurements of heights, distances and angles.

This DT8-Series is design with the absolute encoding angle measuring system. Integrates optical, mechanical, electronic and computer technologies all in one, realizing a variety of functions including angle measurement, display and storage.

This instrument also display horizontal and vertical angles and realize conversion from vertical angle to gradient and compensation of vertical angle.

This series of electronic theodolite find wide applications in the Grade III and Grade IV triangle control measurement in national and urban projects, including engineering measurement in railway, highway, bridge, water conservancy, mining projects, etc. It can be also used in various engineering in construction, erection of large equipment and land register and topographic survey and various kinds of engineering measurement .

FEATURES

The numbering of the product features shown refers to the illustration of the instrument on the graphic page.

1. Carrying Handle
2. Hand Screw (2)
3. Telescope Objective Lens
4. Focusing Knob
5. Eyepiece
6. Target Sight-Collimator
7. LCD Display (2)
8. Circular Leveling Vial
9. Horizontal clamp Knob
10. Horizontal Target Fine Motion Screw
11. Optical Plummet with Focus (DT8-05P and DT8-05LS only)
12. Leveling Screw (3)
13. Tribrach Locking Lever
14. Telescope Vertical Clamp Knob
15. Vertical Tangent Fine Motion Screw
16. Battery Case
17. Tubular Plate Leveling Vial
18. 5/8-11 Thread Base





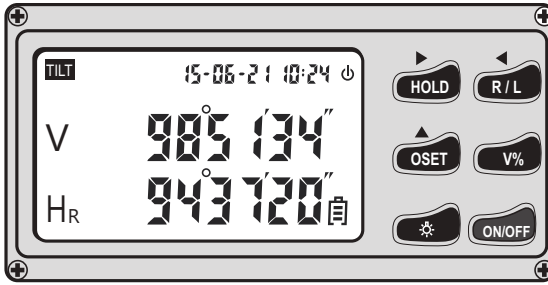

TECHNICAL DATA

Description	DT8-05P	DT8-05LP	DT8-05LS
Telescope			
Objective aperture	1.77 in (45 mm)	1.77 in (45 mm)	1.77 in (45 mm)
Magnification	30X	30X	30X
Image	Erect	Erect	Erect
Field of view	1° 30'	1° 30'	1° 30'
Resolution	3"	3"	3"
Minimum focus	53 in (1.3 m)	53 in (1.3 m)	53 in (1.3 m)
Stadia constant	100	100	100
Electronic Angle Measurement			
Angle measurement	Absolute Encoding	Absolute Encoding	Absolute Encoding
Minimum reading	1" / 5"	1" / 5"	1" / 5"
Direction method	H. Both sides, V. Single side	H. Both sides, V. Single side	H. Both sides, V. Single side
Accuracy	5"	5"	5"
Unit of angle	Deg / mil / gon / V%	Deg / mil / gon / V%	Deg / mil / gon / V%
Display	LCD both sides	LCD both sides	LCD both sides

Description	DT8-05P	DT8-05LP	DT8-05LS
Tilt Sensor			
Automatic Compensation	Yes	Yes	Yes
Range of Compensation	+/-3'	+/-3'	+/-3'
Plummet			
Plummet Type	Optical	Laser	Optical
Magnification	3X	-	3X
Field of view	5°	-	5°
Focusing range	20 in to infinity (0.5 m to infinity)	-	20 in to infinity (0.5 m to infinity)
Reticle type	Crosshair	-	Crosshair
Laser power		≤ 1mW	
Facular diameter		≤ 2mm	
Centering precision		1.5mm (instrument height 1.5m)	
Level Vial Sensitivity			
Plate vial	30" per 2 mm	30" per 2 mm	30" per 2 mm
Circular vial	8' per 2 mm	8' per 2 mm	8' per 2 mm
Display Operating Range			
Operating voltage, typical	4.8 VDC	4.8 VDC	4.8 VDC
Batteries	4 x 1.5V (AA)/ Rechargeable Ni-MH	4 x 1.5V (AA)/ Rechargeable Ni-MH	4 x 1.5V (AA)/ Rechargeable Ni-MH
Operating Temperature range	-4 °F to +122 °F (-20 °C to +50 °C)	-4 °F to +122 °F (-20 °C to +50 °C)	-4 °F to +122 °F (-20 °C to +50 °C)
Waterproof class	IP 54	IP 54	IP 54
Weight	10.2 lb (4.6 kg)	10.2 lb (4.6 kg)	10.2 lb (4.6 kg)
Dimensions	6.5 x 6.1 x 13.4 in (164 x 154 x 340 mm)	6.5 x 6.1 x 13.4 in (164 x 154 x 340 mm)	6.5 x 6.1 x 13.4 in (164 x 154 x 340 mm)

OPERATING KEYS



Button	Primary Function	Secondary Function
	ON/OFF button for displays	<ol style="list-style-type: none"> 1. Function button for entering into Instrument Setup. 2. Function button for entering into Index Error Setting. 3. Function button for entering into Compensation Setting.
	ON/OFF button for illumination of display and telescope crosshair	<p>Turns ON the laser plummet for the DT8-05LP</p> <p>Turns ON the laser site for the DT8-05LS</p>
	<p>OSET Button for zeroing the horizontal circle:</p> <p>Sets the horizontal indication to zero (press twice).</p>	<ol style="list-style-type: none"> 1. Menu selection button in Instrument Setup. 2. Function button for entering into Compensator Setting. 3. Function button for input while in Instrument Setup.
	HOLD button for reading of horizontal circle: for setting or releasing the current horizontal-circle value.	<ol style="list-style-type: none"> 1. Menu selection button in Instrument Setup. 2. Function button for entering while in Instrument Setup. 3. Function button for entering into Index Error Setting.
	Button for counting direction of the horizontal circle: Clockwise direction ("R") or counterclockwise direction ("L")	<ol style="list-style-type: none"> 1. Menu selection button in Instrument Setup. 2. Function button for input while in Instrument Setup.
	Button for vertical angle indication and slope unit of angle	<ol style="list-style-type: none"> 1. Function button for input while in Instrument Setup. 2. Button for confirmation after Initial Setup.

PREPARATION

Inserting/Replacing the Battery

This instrument has two power options: Disposable AA batteries or rechargeable batteries.

The rechargeable batteries are supplied in a sealed pack. The disposable AA batteries are inside a similar shaped pack with a sliding door.

Removing the Battery Pack

⚠ WARNING Power OFF the instrument's before removing the battery pack.

To remove the battery pack, turn the locking knob until the mark ► points to **UNLOCK**.



To insert battery pack, place the bottom of the battery case into the slot.

Push the top of the battery case **16** in towards the housing. Turn the knob until the mark ► points to **LOCK**.

Charging the Rechargeable Batteries

- **Do not use a different battery charger.** The battery charger provided is matched to the rechargeable battery installed in your instrument.

⚠ WARNING Observe the mains voltage! The voltage of the power source must correspond with the data on the type plate of the battery charger.

The batteries are supplied partially charged. To ensure full capacity  of the batteries, completely charge the batteries before the first use.

- Connect the charger to the AC power source. The green light on the charger will luminate.
- Connect the charger to the charging port of the rechargeable battery pack. The green light of the charger will turn red indicating the charging process has started. After 3-4 hours the red light turns green indicating that the batteries are charged.

Caution: Do not charge Alkaline Batteries. Severe damage can happen to the battery pack or charger.

Using Alkaline Battery Pack

To Install Alkaline Batteries into the disposable battery pack, open the battery pack cover, insert four AA alkaline batteries.

When inserting batteries, pay attention to the correct polarity according to the representation on the inside of the battery compartment.

Always replace all batteries at the same time. Only use batteries from one brand and with the identical capacity.

Remove the battery pack from the tool when not using it for extended periods. When storing for extended periods, the batteries can corrode and discharge themselves.

OPERATION

Initial Operation

⚠ WARNING Protect the instrument against moisture and direct sun light.

Do not subject the instrument to extreme temperatures or variations in temperature. As an example, do not leave it in vehicles for long time. In case of large variations in temperature, allow the instrument to adjust to the ambient temperature before putting it into operation. In case of extreme temperatures or variations in temperature, the accuracy of the instrument can be impaired.

Avoid heavy impact or falling of the instrument. After heavy exterior impact on the instrument, an accuracy check should always be carried out before continuing to work.

Setting Up Instrument

⚠ WARNING It is important that the tripod is set up firmly.

Make sure that the tripod points are well into the ground. On paved surfaces, be sure the points hold securely.

The legs should have about a 3-1/2 foot spread, positioned so the top of the tripod head appears level.

If using a tripod with adjustable legs, be sure the leg clamps are securely hand tightened.

Before setting up your instrument, be sure clamps are loosened and both telescope lock levers are in the closed position.

Attach the instrument to the tripod securely, hand tightening the instrument base to the 5/8-11 tripod head.

Setting Up Over a Point

⚠ WARNING Never use force on any parts of the instrument.

All moving parts will turn freely and easily by hand.

The DT8-05P and DT8-05LS is equipped with an optical plummet. The DT8-05LP is equipped with a laser plummet.

This eliminates the need to use a plumb bob. The instrument is set up over a reference point by looking through an eyepiece and optically lining up over the point (DT8-05P and DT8-05LS) or using the laser plummet beam (DT8-05LP).

Move the tripod and instrument over the approximate point. (Be sure the tripod is set up firmly again. Loosen leveling screws and shift the instrument laterally until the instrument is positioned directly over the point.

Positioning Directly Over Point Using Optical Plummet

When looking through the eyepiece **11** the light path is reflected through center of the instrument to the reference point (a stake on the ground).

- Line up the tripod over the reference point.
- Remove the plumb bob hanger from the center stud of the tripod.
- Attach the instrument to the tripod.
- Level the instrument.
- Use the optical plummet to view the reference point on the ground. Sight through the optical plummet eyepiece **11** located beneath the telescope eyepiece.
- Turn the optical plummet eyepiece **11** to bring the crosshairs into focus.

NOTE: The image seen in the eyepiece is reversed left to right. This is important to remember when shifting the instrument or tripod to center over the reference point.

- Line up the crosshairs with the reference point.



If necessary, the instrument can be shifted by loosening the tripod center stud and sliding the instrument from side to side for proper positioning.

Positioning Directly Over Point Using Laser Plummet

To switch ON the laser plummet, press and release the  button. A laser point will project through the center of the instrument to the reference point (a stake on the ground).

- Line up the tripod over the reference point.
- Remove the plumb bob hanger from the center stud of the tripod.
- Attach the instrument to the tripod.
- Level the instrument.
- Line up the laser point with the reference point.

If necessary, the instrument can be shifted by loosening the tripod center stud and sliding the instrument from side to side for proper positioning.

Leveling the Instrument

Center the instruments circular vial **8** by carefully extending or shortening the tripod leg closest to the bubble. Caution: Use only two legs. Repeat until alignment is within 1/4-in (6 mm).

Set the instrument leveling screws. Turn down the leveling screws **12** until firm contact is made with the instrument base.

CAUTION Do not overtighten the leveling screws. It is very possible to overtighten the leveling screws. Only a firm contact between the screws and the base is necessary. If the instrument shifts on the base, turn down the screw more firmly by hand.

Leveling the instrument so the vial bubble remains centered through a 360° rotation of the telescope is the most important operation in preparing to use your instrument.

When leveling your instrument, be sure not to touch the tripod. Follow these instructions carefully.

Use the tubular vial **17** to accurately level the instrument. Unlock **13** and turn the instrument so that the tubular vial **17** is parallel to **BC**, any two leveling screws.

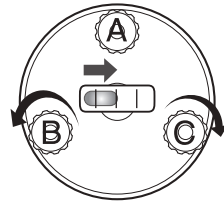

- Note the direction to turn the leveling screws. When turning the two screws, adjust them equally. The bubble will move in the direction that your left thumb turns.
- To move the bubble to the right, turn the **B** leveling screw in and simultaneously turn the **C** leveling screw in.
- To move the bubble left, move both screws out simultaneously.

Once centered turn the instrument 90° over **A** leveling screw and turn screw **A** in or out until bubble is centered.

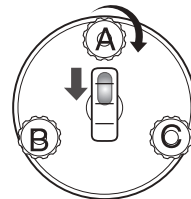

Go back to the first position **BC**, and repeat until the bubble is centered in both positions. Then from position **BC** turn 180° to check the adjustment.

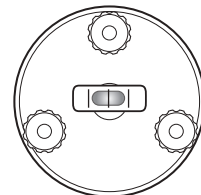

If the bubble stays centered or within 1/4 division, you are leveled.

Next, check the ground point centering. If you are not directly on the point, carefully loosen the tripod fastener and move the instrument on the tripod head in an x - y

direction. Do not rotate the instrument. Recheck leveling and repeat until instruments is level and over the ground point at the same time. With practice, this becomes easier.

Telescope Eyepiece Focus

Adjustment of Eyepiece

Direct the telescope to a bright background. Turn the eyepiece ring so that the crosshairs of the reticule are clearly seen.

Elimination of Optical Parallax

Adjust the focusing ring to clearly see an object on the reticule. Move your eyes up and down to see if the image of the object moves relative to the graduation lines. If it does not move, there is no optical parallax; otherwise turn the focusing ring to eliminate the optical parallax.

Parameter Settings

Please enter all desired initial settings prior to the first measurement.

Items in bold indicate factory settings.

Initial Setting	Selection
1. Unit of Angle	360° / 400G / 6400 Unit A / Unit B / Unit C
2. Zenith Angle	ZEN == 0 / ZEN == 90
3. Auto Power Off Time	30 OFF / NO OFF
4. Min. Display	dsp1 / dsp5
5. Tilt Sensor Switch	TILT ON / TILT OFF
6. Indication of Horizontal Angle Position	No Beep / 90° Beep

Changing Parameter Settings

Press and hold **HOLD** button and **OSET** button, and press **ON/OFF** button.

Release **ON/OFF** button when the full character display appears and release **HOLD** and **OSET** buttons when four beeps are heard. The instrument enters into its initial setup mode and the LCD displays:



- Press ► button or ◀ button to change screens for selecting options.
- Press ▲ button for selecting specific content in the options.
- Finally, press **V%** button to confirm and enter into angle measuring mode.

Unit of Angle

- UNIT A: 360° (Degree)
- UNIT B: 400 (GON)
- UNIT C: 6400 (Mil)

Zero Position of Vertical Angle

- ZEN == 0 : Zenith is 0°
- ZEN == 90 : Zenith is 90°



Auto Power Off Time

- NO OFF: Auto power off disabled
- 30 OFF: Turns power off if inactive for 30 min



Minimum Display

- DSP 1: Minimum display is 1"
- DSP 5: Minimum display is 5"

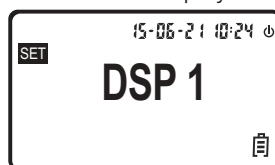

Setting of Tilt Sensor

- V TILT ON: Turn on the tilt sensor
- V TILT OFF: Turn off the tilt sensor



Indication of Horizontal Angle

- NO BEEP: Horizontal angle indication disabled
- 90 BEEP: Sounds beep when the instrument is close to 0°, 90°, 180° and 270°

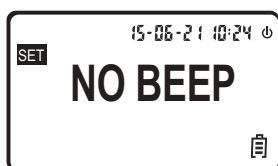

Start Up

Press and hold **ON/OFF** button. Release **ON/OFF** button when the full character display appears. The LCD displays:

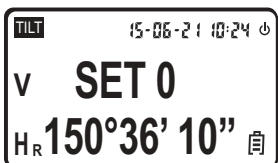

- Move the telescope up and down when the instrument is at the normal position. The beeper beeps and the LCD displays the vertical angle. The instrument enters into measuring mode.
- After the power is switched on and the instrument has entered into measuring mode, the battery level is indicated by the battery symbol  in the lower right corner of LCD.
- If all of the three squares are charged, the battery is fully charged.
- Decreasing squares indicates reduction of charge.

- If the battery symbol blinks, the battery is low and needs recharging or replacing.

Measurement of Angle

Observing in the “Normal” and “Reverse” Positions of the Telescope

The normal, or direct, position of the telescope refers to observation with the vertical circle being on the left. The reverse position refers to observation with the vertical circle being on the right. The mechanical errors can be offset by averaging the values measured in the normal and reverse positions.

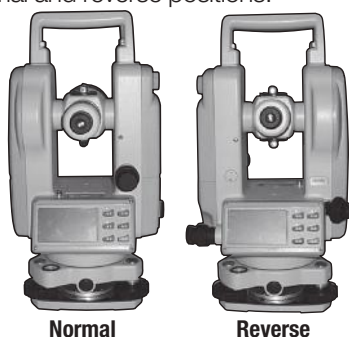

Measurement of Vertical Angle

- 0° angle position can be set as follows in the initial setting:

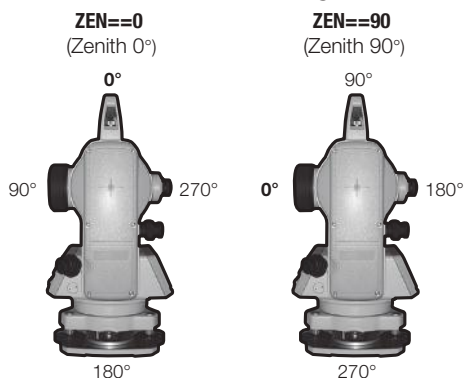

Compensation of the Tilt Sensor to Vertical Angle

- If the instrument is inclined within $\pm 3'$, the tilt sensor can compensate the vertical angle.



- If the inclination is greater than $\pm 3'$, the instrument will display **TILT** as shown in the figure.



Display of Slope

- Press **V%** button, the vertical angle display is changed to slope display.

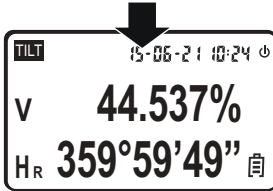
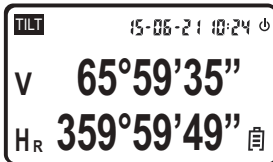

- Press **V%** button again, the vertical angle display is resumed.

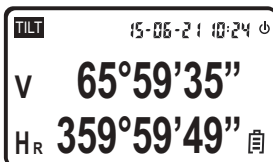

Note: When vertical angle is converted to slope, the precision of the slope reading is two digits after the decimal. The value of slope is displayed only within $\pm 45^\circ$ (100%). There will be no slope display exceeding this range.

Measurement of Horizontal Angle

- Reset horizontal angle.**
Press **OSET** button, the horizontal angle returns to zero.

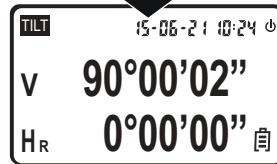
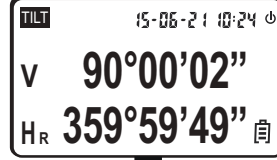

- Selecting the direction of horizontal angle measurement.**

Press **R/L** button to change the direction of measurement of the horizontal angle.

When "HR" is displayed, the angle increases with clockwise turning.

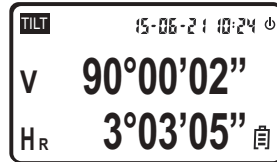

When "HL" is displayed, the angle increases with counterclockwise turning.

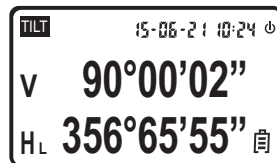

- Holding the Horizontal Angle.**
 Press **HOLD** button, the horizontal angle will be held. The reading of the horizontal angle will remain unchanged even if the direction of telescope is changed.

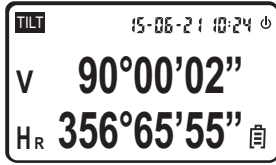

Press **HOLD** button again, the hold of horizontal angle is released.

Turning Instrument Off

- Press **ON/OFF** button, "OFF" will be displayed at the position of vertical angle display after a beep; release **ON/OFF** button, the instrument is turned off.



Measuring Distance Using the Stadia Method

Distance measurement can be done using the stadia hairs of the reticle.

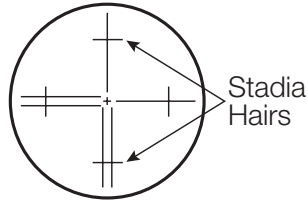

Read the length "ℓ" of a level rod shown between the stadia hairs.

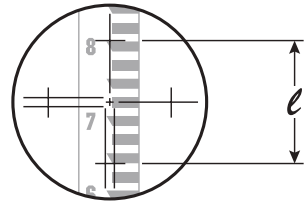

The distance to the target is "ℓ" multiplied by 100. The distance between point A and point B is L.

$$L = 100 \times \ell$$

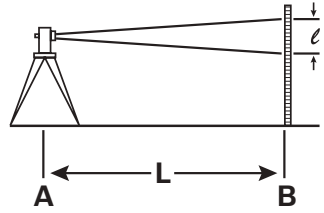

TRIBRACH

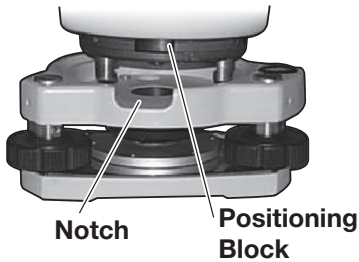
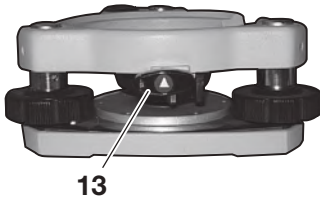

Removal

- Turn the screw on the tribrach locking Lever **13** outward using a flat screw driver to its stop.
- Turn the tribrach locking lever **13** 180° counterclockwise. Holding the base with one hand, take the main body off the base.

Attachment

- Turn the tribrach locking lever **13** counterclockwise until it reaches the position limit.
Align the positioning block on the main body of the instrument to the notch on the base. Install the main body onto the base.
- Turn the tribrach locking lever **13** clockwise until it reaches the position limit so that the 'v' mark points downward.
- Turn the screw inward until it hits its stop.

CHECKS AND ADJUSTMENTS

When attempting to check and adjust the instrument, corrections must be made in a certain order to ensure the adjustments are correct.

Order of adjustment:

1. Check and adjust the tubular plate vial **17**.
2. Check and adjust the circular leveling vial **8**.
3. Check and adjust the optical plummet **11** (DT8-05P & DT8-05LS)

Always recheck your adjustments. We recommend that any adjustments, other than those above, be done by a qualified repair technician.

Tubular plate vial

- A. Place the plate vial parallel to the leveling screws, A and B. Center the bubble using these two level screws.
- B. Turn the instrument 90° and center

the bubble using leveling screw C.

- C. Return to the original position in step A. Recheck the bubble and center as necessary. Rotate the instrument 180°. The bubble should still be centered in the vial. If not, go to next step.
- D. Using the adjusting pin, provided in the case, turn the screw until the bubble moves halfway back to its original position.



- E. Return the instrument to its original position and repeat steps A through C. Repeat these steps until the bubble stays centered in all positions.

Circular Leveling Vial

If the circular vial is centered after leveling the plate vial, then no further adjustment is necessary. If not, proceed with the following adjustment.

- A. Using the adjusting pin, provided in the case, turn the adjusting screws until the bubble is centered in the vial.

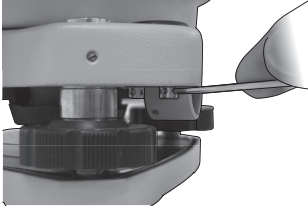

Do not over tighten the adjusting screws

- B. Loosen one screw by turning it 1/4 turn, then tighten the other screw by 1/4 turn.

Optical Plummet

This adjustment is required to make the line of sight of the optical plummet coincide with the vertical axis.

- A. Point the optical plummet at a ground target. This can be done by adjusting the level screws or by loosening the instrument fastening screw and moving the instrument over the target.
- B. Turn the instrument 180° and re-sight the target through the optical plummet. If the target is still centered, no adjustment is necessary. If not, go to next step.

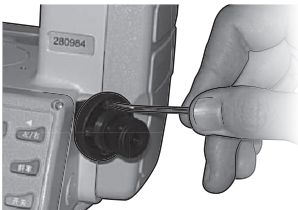

- D. Using the adjusting pin, provided in the case, turn the reticle adjusting screws until half the displacement has been removed. Loosen one screw 1/4 turn, then tighten the opposing screw 1/4 turn.

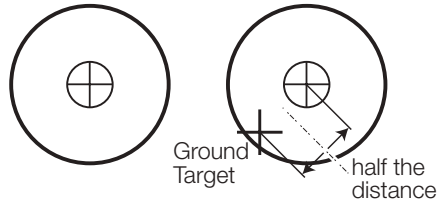

- E. Repeat steps A through D until there is no displacement of the target when the instrument is turned about its vertical axis.

Collimation Error

- Attach the instrument on a tripod and precisely level.
- Aim at point A in the distance with the normal, direct position of telescope. Record the reading of the horizontal angle - **HR-DIRECT**.
- Using the reverse position of the telescope, take the reading of the horizontal angle - **HR-REVERSE**, then:

$$\text{Collimation Error } C = \frac{(\text{HR-Direct} - \text{HR-Reverse} \pm 180^\circ)}{2}$$

If $C < 10''$, no adjustment is required.

If $C > 10''$, the following adjustment is required:

- Adjust the horizontal fine motion in the reverse position of the telescope so that the reverse reading **HR-Rev = HR-Rev + C**.
- Remove the protective cover of the reticle of the telescope and adjust both the left and right adjusting screws so that the vertical hair of the reticle coincides with object A.
- Repeat the steps until acceptable condition is reached.

Index Error of Vertical Circle

- Attach the instrument on a tripod and precisely level.
- Aim at any object, point P, in the normal position and take the reading of vertical angle - V-Direct.
- Turn the telescope to the reverse position and aim it at point P again. Take the reading of other vertical angle - V-Rev.

If **(V-Direct + V-Rev) - 360° = ≤15"**, no adjustment is required. Otherwise, perform adjustment as follows:

- Press and hold **R / L** and **HOLD** buttons while pressing **ON/OFF** button.
- Release **ON/OFF** button when full character display appears and then release **R / L** and **HOLD** buttons when four beeps are heard.
- Swing the telescope near horizontal with the instrument in the normal position.
- Allow the vertical angle to reset after it crosses zero. Aim the telescope in the normal position at object P and press **OSET** to confirm.

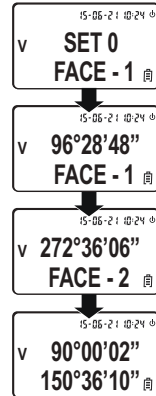

ERROR CODES

Display	Problem and Solution
E08	Horizontal or vertical counting error, repair is needed.
TOO FAST	Turn telescope or collimation too fast. Sway telescope to be re-0set in normal position.
TILT	Vertical tilt sensor is out of compensation range. Re-level theodolite. If 'TILT' still displays, repair is needed. Note: For a temporary solution, the tilt sensor can be turned off.

MAINTENANCE AND SERVICE

Store and transport the tool only in the supplied protective case.

Keep the tool clean at all times.

Do not immerse the tool into water or other fluids.

Wipe off debris using a moist and soft cloth. Do not use any cleaning agents or solvents.

Regularly clean the surfaces at the exit opening of the laser in particular, and pay attention to any fluff of fibers.

If the tool should fail despite the care taken in manufacturing and testing procedures, repair should be carried out by an authorized after-sales service center for Dave White's SitePro instruments. In all correspondence and spare parts orders, please always include the

model number and serial number of the instruments.

All precision instruments should be cleaned, lubricated, checked and adjusted ONLY at a qualified instrument repair station or by the manufacturer, at least once a year.

In case of repairs, send in the instrument packed in its protective case.

ENVIRONMENT PROTECTION

Recycle raw materials & batteries instead of disposing of waste. The unit, accessories, packaging & used batteries should be sorted for environmentally friendly recycling in accordance with the latest regulations.



LIMITED WARRANTY

Dave White's SitePro ("Seller") warrants to the original purchaser only, that this optical instrument will be free from defects in material or workmanship for a period of two (2) years from date of purchase.

SELLER'S SOLE OBLIGATION AND YOUR EXCLUSIVE REMEDY under this Limited Warranty and, to the extent permitted by law, any warranty or condition implied by law, shall be the repair or replacement of parts, without charge, which are defective in material or workmanship and which have not been misused, carelessly handled, or mis-repaired by persons other than Seller or an Authorized Service Center. To make a claim under this Limited Warranty, you must return the complete product, transportation prepaid, to any David White/SitePro Authorized Service Center. Please include a dated proof of purchase with your tool. For locations of nearby service centers, email us at info@sitepro.us.com or call 1-855-354-9881.

THIS LIMITED WARRANTY DOES NOT APPLY TO ACCESSORY ITEMS SUCH AS TRIPODS, RODS, HAND LEVELS, FIELD SUPPLIES, TAPES, MOUNTING DEVICES AND OTHER RELATED ITEMS. THESE ITEMS RECEIVE A 90 DAY LIMITED WARRANTY.

Magnetic locators are warranted for a period of seven (7) years from date of purchase.

All laser detectors will be free from defects in material or workmanship for a period of one (1) year from date of purchase.

ANY IMPLIED WARRANTIES SHALL BE LIMITED IN DURATION TO ONE YEAR FROM DATE OF PURCHASE. SOME STATES IN THE U.S., AND SOME CANADIAN PROVINCES DO NOT ALLOW LIMITATIONS ON HOW LONG AN IMPLIED WARRANTY LASTS, SO THE ABOVE LIMITATION MAY NOT APPLY TO YOU.

IN NO EVENT SHALL SELLER BE LIABLE FOR ANY INCIDENTAL OR CONSEQUENTIAL DAMAGES (INCLUDING BUT NOT LIMITED TO LIABILITY FOR LOSS OF PROFITS) ARISING FROM THE SALE OR USE OF THIS PRODUCT. SOME STATES IN THE U.S., AND SOME CANADIAN PROVINCES DO NOT ALLOW THE EXCLUSION OR LIMITATION OF INCIDENTAL OR CONSEQUENTIAL DAMAGES, SO THE ABOVE LIMITATION MAY NOT APPLY TO YOU.

THIS LIMITED WARRANTY GIVES YOU SPECIFIC LEGAL RIGHTS, AND YOU MAY ALSO HAVE OTHER RIGHTS WHICH VARY FROM STATE TO STATE IN THE U.S., OR PROVINCE TO PROVINCE IN CANADA AND FROM COUNTRY TO COUNTRY.

THIS LIMITED WARRANTY APPLIES ONLY TO PRODUCTS SOLD WITHIN THE UNITED STATES OF AMERICA, CANADA AND THE COMMONWEALTH OF PUERTO RICO. FOR WARRANTY COVERAGE WITHIN OTHER COUNTRIES, CONTACT YOUR LOCAL SITEPRO DEALER OR IMPORTER.

David White is a registered trademark and offered exclusively by Dave White's SitePro.

©2017 Dave White's SitePro LLC
Otterbein, IN USA
www.sitepro.us.com